

## General Description

The GreenMOS<sup>®</sup> high voltage MOSFET utilizes charge balance technology to achieve outstanding low on-resistance and lower gate charge. It is engineered to minimize conduction loss, provide superior switching performance and robust avalanche capability.

The GreenMOS<sup>®</sup> Generic series is optimized for extreme switching performance to minimize switching loss. It is tailored for high power density applications to meet the highest efficiency standards.

## Features

- Low  $R_{DS(ON)}$  & FOM
- Extremely low switching loss
- Excellent stability and uniformity



## Applications

- PC power
- LED lighting
- Telecom power
- Server power
- EV Charger
- Solar/UPS

## Key Performance Parameters

Parameter	Value	Unit
$V_{DS, min} @ T_{j(max)}$	850	V
$I_D, pulse$	24	A
$R_{DS(ON)}, max @ V_{GS}=10V$	650	m $\Omega$
$Q_g$	12.1	nC

## Marking Information

Product Name	Package	Marking
OSG80R650PF	TO220	OSG80R650P

## Package & Pin Information

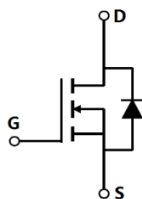

**Absolute Maximum Ratings** at  $T_j=25^{\circ}\text{C}$  unless otherwise noted

Parameter	Symbol	Value	Unit
Drain-source voltage	$V_{DS}$	800	V
Gate-source voltage	$V_{GS}$	$\pm 30$	V
Continuous drain current <sup>1)</sup> , $T_C=25^{\circ}\text{C}$	$I_D$	8	A
Continuous drain current <sup>1)</sup> , $T_C=100^{\circ}\text{C}$		5	
Pulsed drain current <sup>2)</sup> , $T_C=25^{\circ}\text{C}$	$I_{D, pulse}$	24	A
Continuous diode forward current <sup>1)</sup> , $T_C=25^{\circ}\text{C}$	$I_S$	8	A
Diode pulsed current <sup>2)</sup> , $T_C=25^{\circ}\text{C}$	$I_{S, pulse}$	24	A
Power dissipation <sup>3)</sup> , $T_C=25^{\circ}\text{C}$	$P_D$	83	W
Single pulsed avalanche energy <sup>5)</sup>	$E_{AS}$	240	mJ
MOSFET dv/dt ruggedness, $V_{DS}=0\dots 480\text{ V}$	dv/dt	50	V/ns
Reverse diode dv/dt, $V_{DS}=0\dots 480\text{ V}$ , $I_{SD}\leq I_D$	dv/dt	15	V/ns
Operation and storage temperature	$T_{stg}, T_j$	-55 to 150	$^{\circ}\text{C}$

**Thermal Characteristics**

Parameter	Symbol	Value	Unit
Thermal resistance, junction-case	$R_{\theta JC}$	1.5	$^{\circ}\text{C/W}$
Thermal resistance, junction-ambient <sup>4)</sup>	$R_{\theta JA}$	62	$^{\circ}\text{C/W}$

**Electrical Characteristics** at  $T_j=25^{\circ}\text{C}$  unless otherwise specified

Parameter	Symbol	Min.	Typ.	Max.	Unit	Test condition
Drain-source breakdown voltage	$BV_{DSS}$	800			V	$V_{GS}=0\text{ V}$ , $I_D=250\ \mu\text{A}$
		850	930			$V_{GS}=0\text{ V}$ , $I_D=250\ \mu\text{A}$ , $T_j=150^{\circ}\text{C}$
Gate threshold voltage	$V_{GS(th)}$	2.0		4.0	V	$V_{DS}=V_{GS}$ , $I_D=250\ \mu\text{A}$
Drain-source on-state resistance	$R_{DS(ON)}$		0.55	0.65	$\Omega$	$V_{GS}=10\text{ V}$ , $I_D=4\text{ A}$
			1.48			$V_{GS}=10\text{ V}$ , $I_D=4\text{ A}$ , $T_j=150^{\circ}\text{C}$
Gate-source leakage current	$I_{GSS}$			100	nA	$V_{GS}=30\text{ V}$
				-100		$V_{GS}=-30\text{ V}$
Drain-source leakage current	$I_{DSS}$			10	$\mu\text{A}$	$V_{DS}=800\text{ V}$ , $V_{GS}=0\text{ V}$

### Dynamic Characteristics

Parameter	Symbol	Min.	Typ.	Max.	Unit	Test condition
Input capacitance	$C_{iss}$		709.1		pF	$V_{GS}=0\text{ V}$ , $V_{DS}=50\text{ V}$ , $f=1\text{ MHz}$
Output capacitance	$C_{oss}$		44.8		pF	
Reverse transfer capacitance	$C_{rss}$		2		pF	
Turn-on delay time	$t_{d(on)}$		25.1		ns	$V_{GS}=10\text{ V}$ , $V_{DS}=400\text{ V}$ , $R_G=25\ \Omega$ , $I_D=4\text{ A}$
Rise time	$t_r$		11.4		ns	
Turn-off delay time	$t_{d(off)}$		43.5		ns	
Fall time	$t_f$		25.5		ns	

### Gate Charge Characteristics

Parameter	Symbol	Min.	Typ.	Max.	Unit	Test condition
Total gate charge	$Q_g$		12.1		nC	$V_{GS}=10\text{ V}$ , $V_{DS}=400\text{ V}$ , $I_D=4\text{ A}$
Gate-source charge	$Q_{gs}$		3.3		nC	
Gate-drain charge	$Q_{gd}$		4.2		nC	
Gate plateau voltage	$V_{plateau}$		5.6		V	

### Body Diode Characteristics

Parameter	Symbol	Min.	Typ.	Max.	Unit	Test condition
Diode forward voltage	$V_{SD}$			1.3	V	$I_S=8\text{ A}$ , $V_{GS}=0\text{ V}$
Reverse recovery time	$t_{rr}$		193.7		ns	$V_R=400\text{ V}$ , $I_S=4\text{ A}$ , $di/dt=100\text{ A}/\mu\text{s}$
Reverse recovery charge	$Q_{rr}$		1.7		$\mu\text{C}$	
Peak reverse recovery current	$I_{rrm}$		15.3		A	

### Note

- 1) Calculated continuous current based on maximum allowable junction temperature.
- 2) Repetitive rating; pulse width limited by max. junction temperature.
- 3)  $P_d$  is based on max. junction temperature, using junction-case thermal resistance.
- 4) The value of  $R_{\theta JA}$  is measured with the device mounted on 1 in 2 FR-4 board with 2oz. Copper, in a still air environment with  $T_a=25\text{ }^\circ\text{C}$ .
- 5)  $V_{DD}=100\text{ V}$ ,  $V_{GS}=10\text{ V}$ ,  $L=20\text{ mH}$ , starting  $T_j=25\text{ }^\circ\text{C}$ .

**Electrical Characteristics Diagrams**

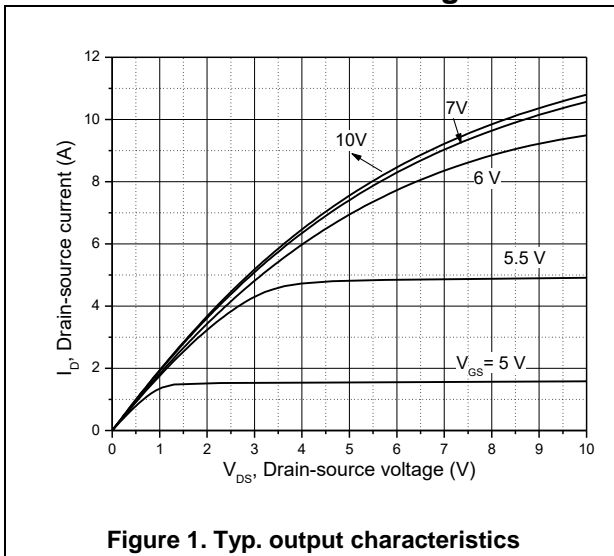

**Figure 1. Typ. output characteristics**

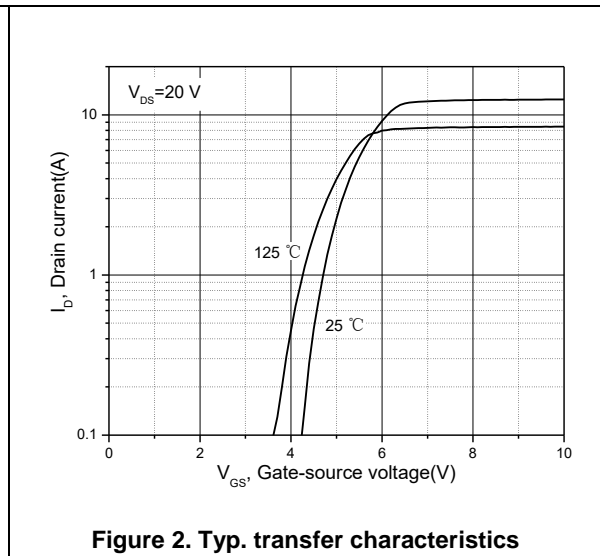

**Figure 2. Typ. transfer characteristics**

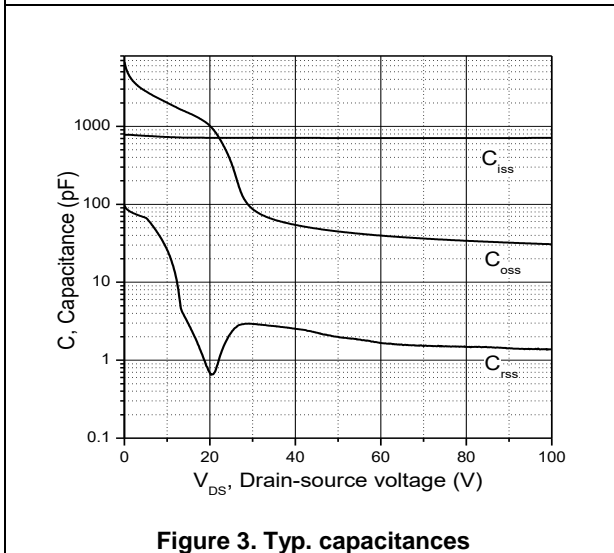

**Figure 3. Typ. capacitances**

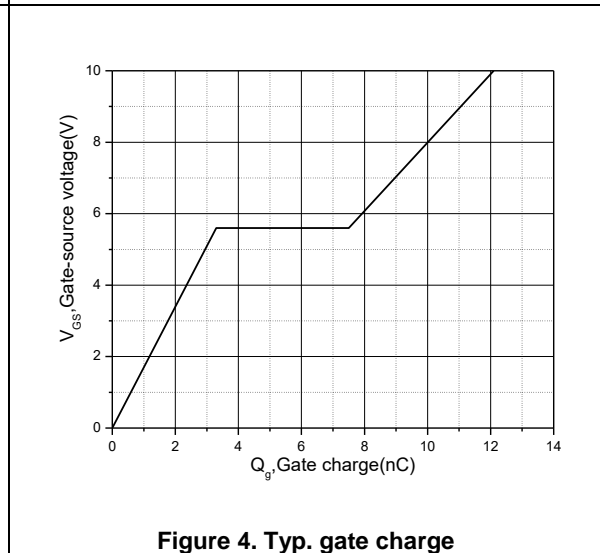

**Figure 4. Typ. gate charge**

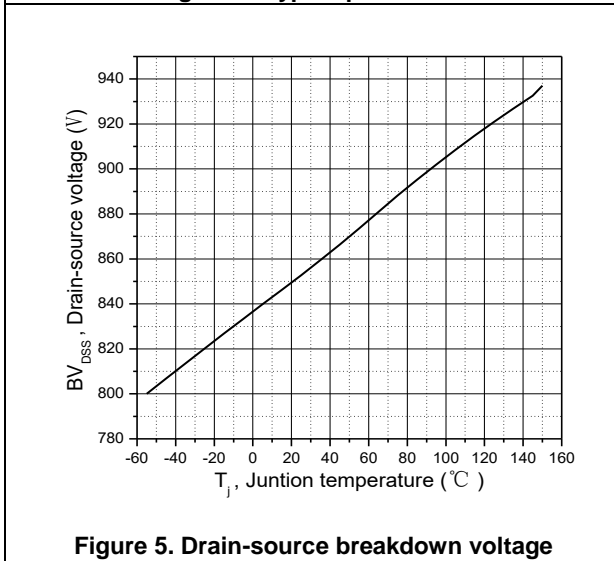

**Figure 5. Drain-source breakdown voltage**

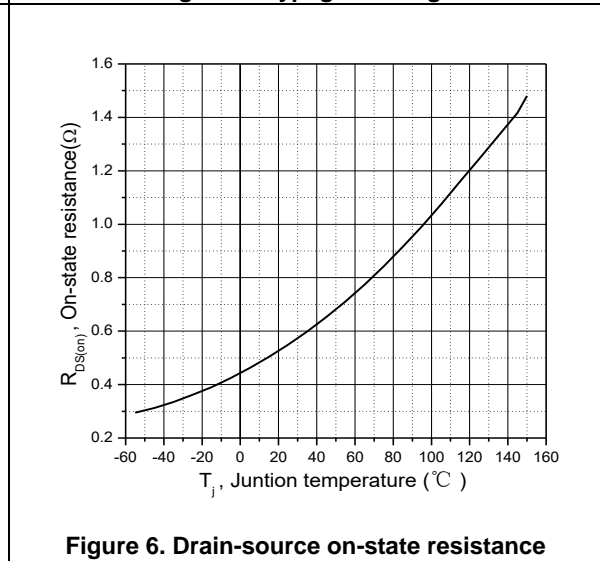

**Figure 6. Drain-source on-state resistance**

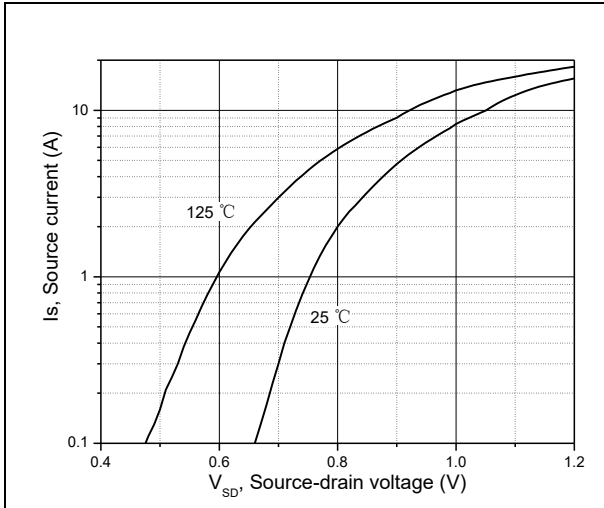

**Figure 7. Forward characteristic of body diode**

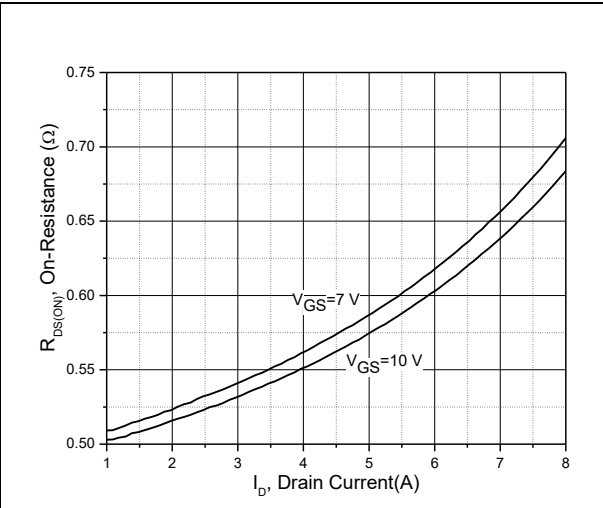

**Figure 8. Drain-source on-state resistance**

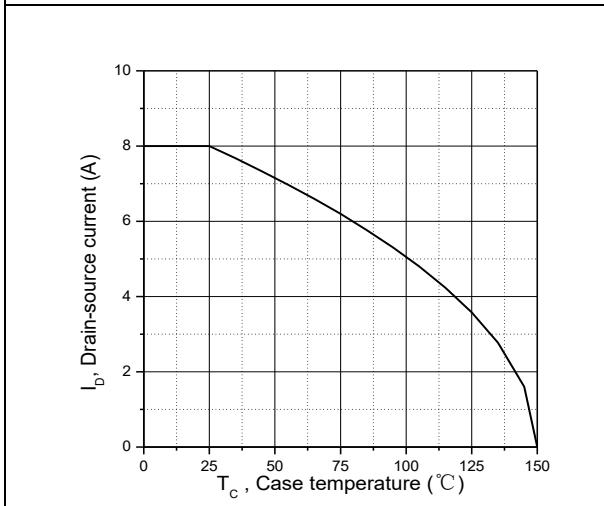

**Figure 9. Drain current**

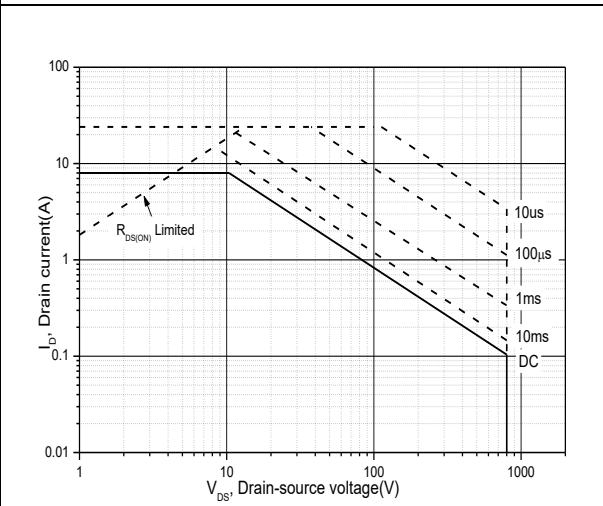

**Figure 10. Safe operation area TC=25 °C**

**Test circuits and waveforms**



**Figure 1. Gate charge test circuit & waveform**



**Figure 2. Switching time test circuit & waveforms**

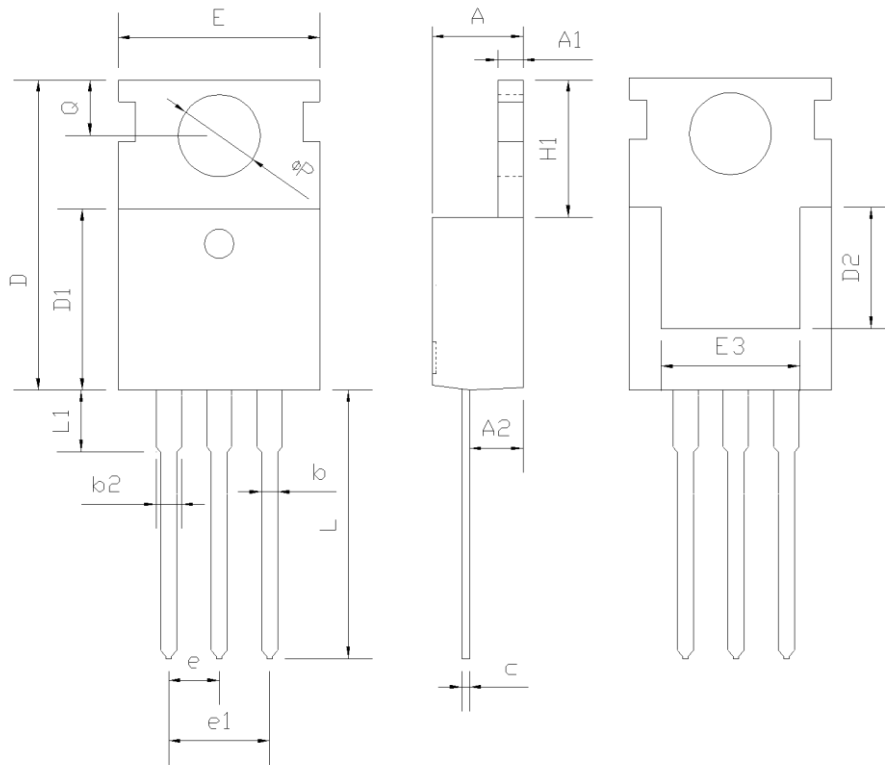

**Figure 3. Unclamped inductive switching (UIS) test circuit & waveforms**



**Figure 4. Diode reverse recovery test circuit & waveforms**

**Package Information**



Symbol	mm		
	Min	Nom	Max
A	4.37	4.57	4.77
A1	1.25	1.30	1.45
A2	2.20	2.40	2.60
b	0.70	0.80	0.95
b2	1.17	1.27	1.47
c	0.40	0.50	0.65
D	15.10	15.60	16.10
D1	8.80	9.10	9.40
D2	5.50	-	-
E	9.70	10.00	10.30
E3	7.00	-	-
e	2.54BSC		
e1	5.08BSC		
H1	6.25	6.50	6.85
L	12.75	13.50	13.80
L1	-	3.10	3.40
ΦP	3.40	3.60	3.80
Q	2.60	2.80	3.00

Version 1: TO220-P package outline dimension

## Ordering Information

Package Type	Units/ Tube	Tubes/ Inner Box	Units/ Inner Box	Inner Boxes/ Carton Box	Units/ Carton Box
TO220-P	50	20	1000	6	6000

## Product Information

Product	Package	Pb Free	RoHS	Halogen Free
OSG80R650PF	TO220	yes	yes	yes

## Legal Disclaimer

The information given in this document shall in no event be regarded as a guarantee of conditions or characteristics. With respect to any examples or hints given herein, any typical values stated herein and/or any information regarding the application of the device, Oriental Semiconductor hereby disclaims any and all warranties and liabilities of any kind, including without limitation, warranties of non-infringement of intellectual property rights of any third party.

For further information on technology, delivery terms and conditions and prices, please contact the Oriental Semiconductor sales representatives ([www.orientalsemi.com](http://www.orientalsemi.com)).

© Oriental Semiconductor Co.,Ltd. All Rights Reserved 