

General Description

FSMOS[®] MOSFET is based on Oriental Semiconductor's unique device design to achieve low $R_{DS(ON)}$, low gate charge, fast switching and excellent avalanche characteristics. The low V_{th} series is specially optimized for synchronous rectification systems with low driving voltage.

Features

- Low $R_{DS(ON)}$ & FOM
- Extremely low switching loss
- Excellent reliability and uniformity
- Fast switching and soft recovery



Applications

- PD charger
- Motor driver
- Switching voltage regulator
- DC-DC convertor
- Switched mode power supply

Key Performance Parameters

Parameter	Value	Unit
$V_{DS, min} @ T_{j(max)}$	30	V
$I_D, pulse$	135	A
$R_{DS(ON), max} @ V_{GS}=10V$	7	m Ω
Q_g	13.1	nC

Marking Information

Product Name	Package	Marking
SFS03R06NF	PDFN3.3*3.3	SFS03R06N

Package & Pin information

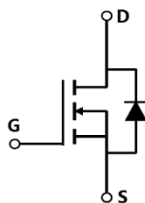

Absolute Maximum Ratings at $T_j=25^{\circ}\text{C}$ unless otherwise noted

Parameter	Symbol	Value	Unit
Drain-source voltage	V_{DS}	30	V
Gate-source voltage	V_{GS}	± 15	V
Continuous drain current ¹⁾ , $T_C=25^{\circ}\text{C}$	I_D	45	A
Pulsed drain current ²⁾ , $T_C=25^{\circ}\text{C}$	$I_{D, pulse}$	135	A
Continuous diode forward current ¹⁾ , $T_C=25^{\circ}\text{C}$	I_S	45	A
Diode pulsed current ²⁾ , $T_C=25^{\circ}\text{C}$	$I_{S, pulse}$	135	A
Power dissipation ³⁾ , $T_C=25^{\circ}\text{C}$	P_D	25	W
Single pulsed avalanche energy ⁵⁾	E_{AS}	25	mJ
Operation and storage temperature	T_{stg}, T_j	-55 to 150	$^{\circ}\text{C}$

Thermal Characteristics

Parameter	Symbol	Value	Unit
Thermal resistance, junction-case	$R_{\theta JC}$	5	$^{\circ}\text{C/W}$
Thermal resistance, junction-ambient ⁴⁾	$R_{\theta JA}$	62	$^{\circ}\text{C/W}$

Electrical Characteristics at $T_j=25^{\circ}\text{C}$ unless otherwise specified

Parameter	Symbol	Min.	Typ.	Max.	Unit	Test condition
Drain-source breakdown voltage	BV_{DSS}	30			V	$V_{GS}=0\text{ V}, I_D=250\ \mu\text{A}$
Gate threshold voltage	$V_{GS(th)}$	1.5		2.5	V	$V_{DS}=V_{GS}, I_D=250\ \mu\text{A}$
Drain-source on-state resistance	$R_{DS(ON)}$		6.3	7.0	m Ω	$V_{GS}=10\text{ V}, I_D=20\text{ A}$
Drain-source on-state resistance	$R_{DS(ON)}$		10	12	m Ω	$V_{GS}=4.5\text{ V}, I_D=20\text{ A}$
Gate-source leakage current	I_{GSS}			100	nA	$V_{GS}=15\text{ V}$
				-100		$V_{GS}=-15\text{ V}$
Drain-source leakage current	I_{DSS}			1	μA	$V_{DS}=30\text{ V}, V_{GS}=0\text{ V}$
Gate resistance	R_G		3		Ω	$f=1\text{ MHz}, \text{Open drain}$

Dynamic Characteristics

Parameter	Symbol	Min.	Typ.	Max.	Unit	Test condition
Input capacitance	C_{iss}		1014		pF	$V_{GS}=0\text{ V}$, $V_{DS}=25\text{ V}$, $f=100\text{ kHz}$
Output capacitance	C_{oss}		274		pF	
Reverse transfer capacitance	C_{rss}		12.6		pF	
Turn-on delay time	$t_{d(on)}$		18.2		ns	$V_{GS}=10\text{ V}$, $V_{DS}=30\text{ V}$, $R_G=2\ \Omega$, $I_D=30\text{ A}$
Rise time	t_r		4.3		ns	
Turn-off delay time	$t_{d(off)}$		28.5		ns	
Fall time	t_f		3.8		ns	

Gate Charge Characteristics

Parameter	Symbol	Min.	Typ.	Max.	Unit	Test condition
Total gate charge	Q_g		13.1		nC	$V_{GS}=10\text{ V}$, $V_{DS}=30\text{ V}$, $I_D=30\text{ A}$
Gate-source charge	Q_{gs}		3.5		nC	
Gate-drain charge	Q_{gd}		1.5		nC	
Gate plateau voltage	$V_{plateau}$		4		V	

Body Diode Characteristics

Parameter	Symbol	Min.	Typ.	Max.	Unit	Test condition
Diode forward voltage	V_{SD}			1.3	V	$I_S=20\text{ A}$, $V_{GS}=0\text{ V}$
Reverse recovery time	t_{rr}		18		ns	$V_R=30\text{ V}$, $I_S=30\text{ A}$, $di/dt=100\text{ A}/\mu\text{s}$
Reverse recovery charge	Q_{rr}		7.1		nC	
Peak reverse recovery current	I_{rrm}		0.6		A	

Note

- 1) Calculated continuous current based on maximum allowable junction temperature.
- 2) Repetitive rating; pulse width limited by max. junction temperature.
- 3) P_d is based on max. junction temperature, using junction-case thermal resistance.
- 4) The value of $R_{\theta JA}$ is measured with the device mounted on 1 in 2 FR-4 board with 2oz. Copper, in a still air environment with $T_a=25\text{ }^\circ\text{C}$.
- 5) $V_{DD}=30\text{ V}$, $V_{GS}=10\text{ V}$, $L=0.3\text{ mH}$, starting $T_j=25\text{ }^\circ\text{C}$.

Electrical Characteristics Diagrams

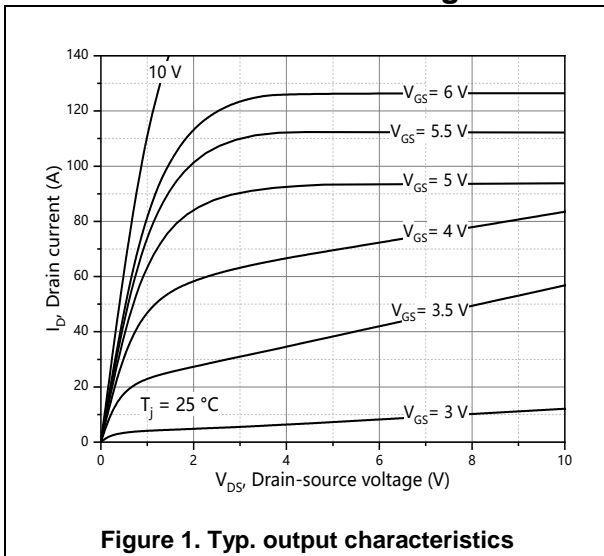

Figure 1. Typ. output characteristics

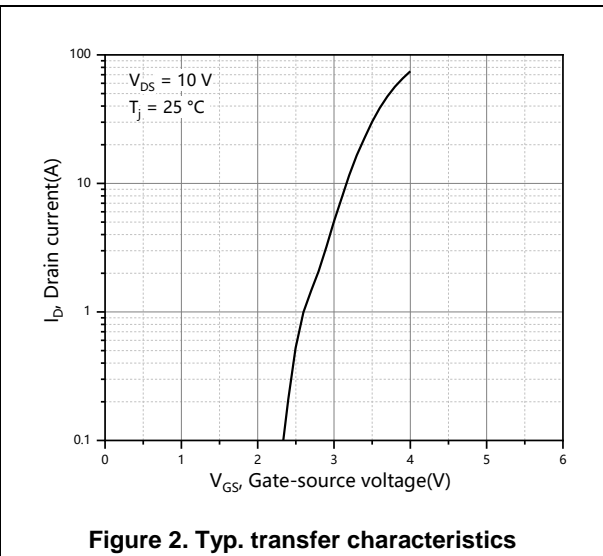

Figure 2. Typ. transfer characteristics

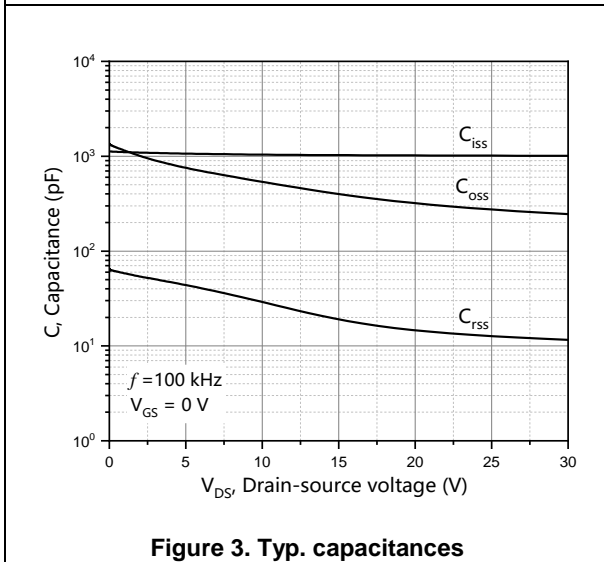

Figure 3. Typ. capacitances

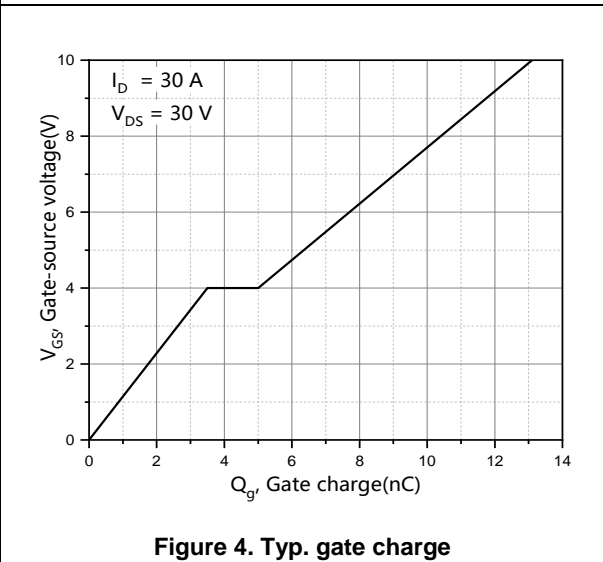

Figure 4. Typ. gate charge

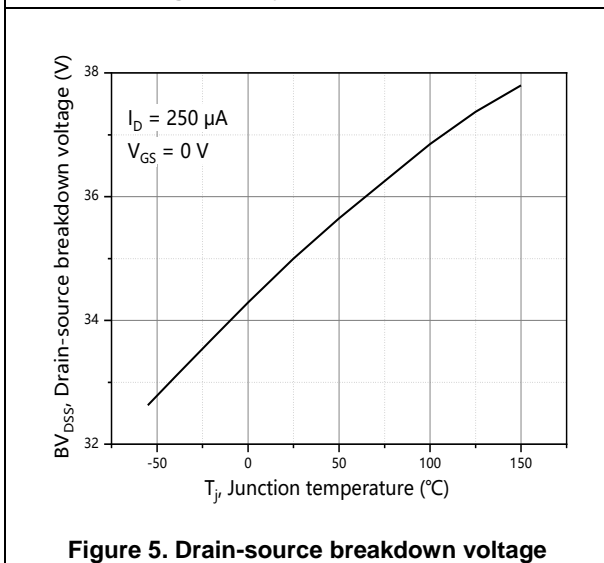

Figure 5. Drain-source breakdown voltage

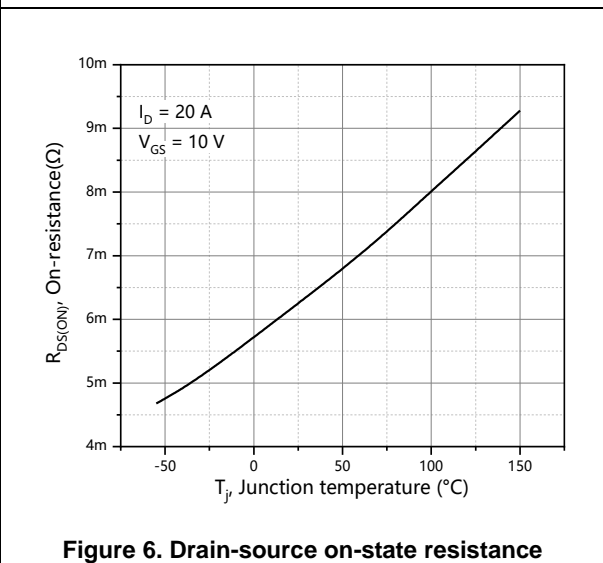
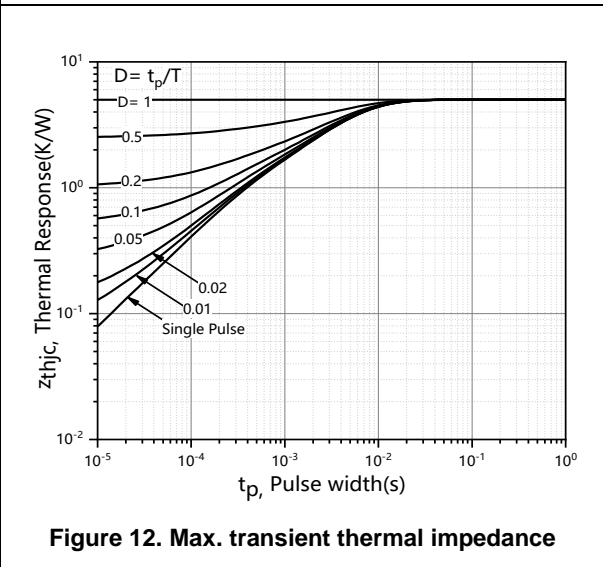
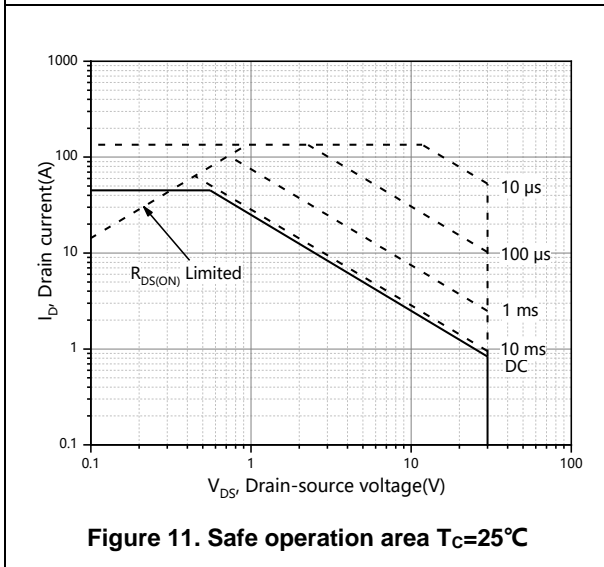
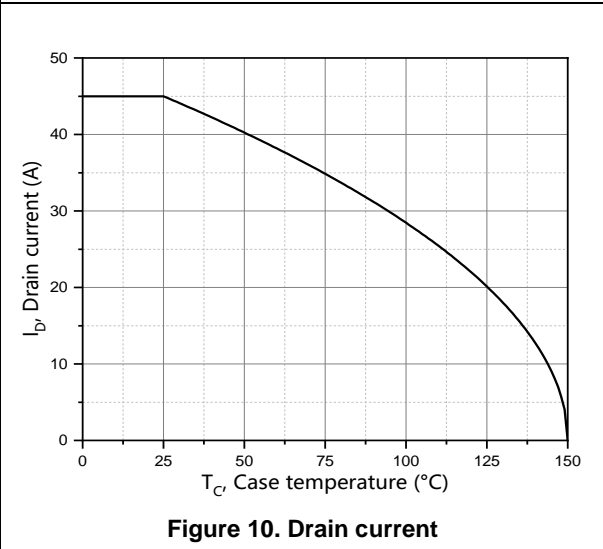
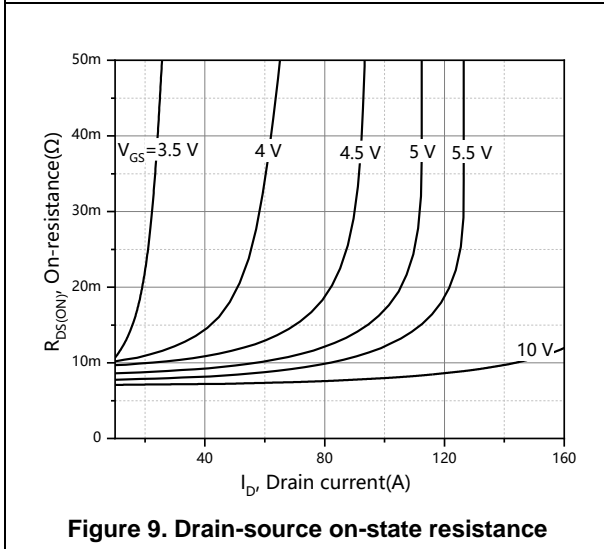
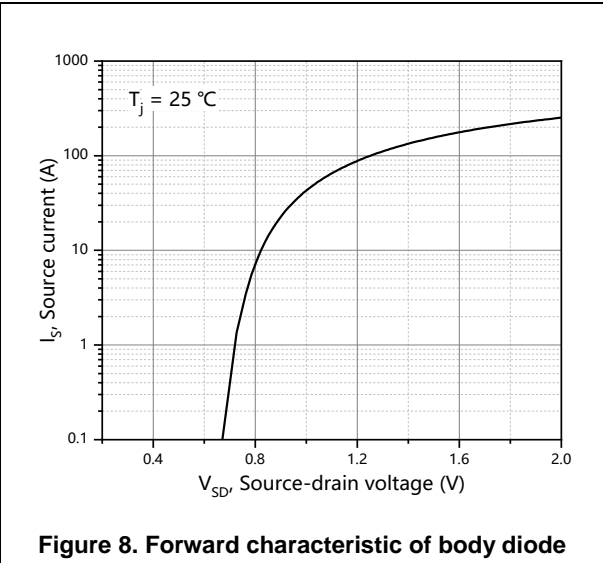
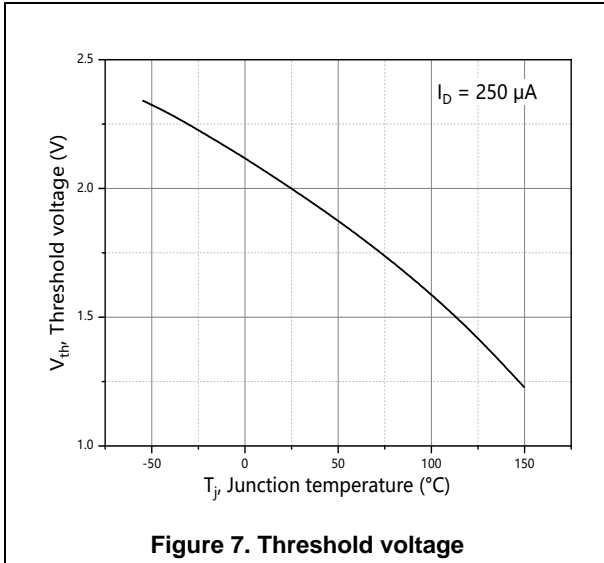

Figure 6. Drain-source on-state resistance



Test circuits and waveforms



Figure 1. Gate charge test circuit & waveform



Figure 2. Switching time test circuit & waveforms

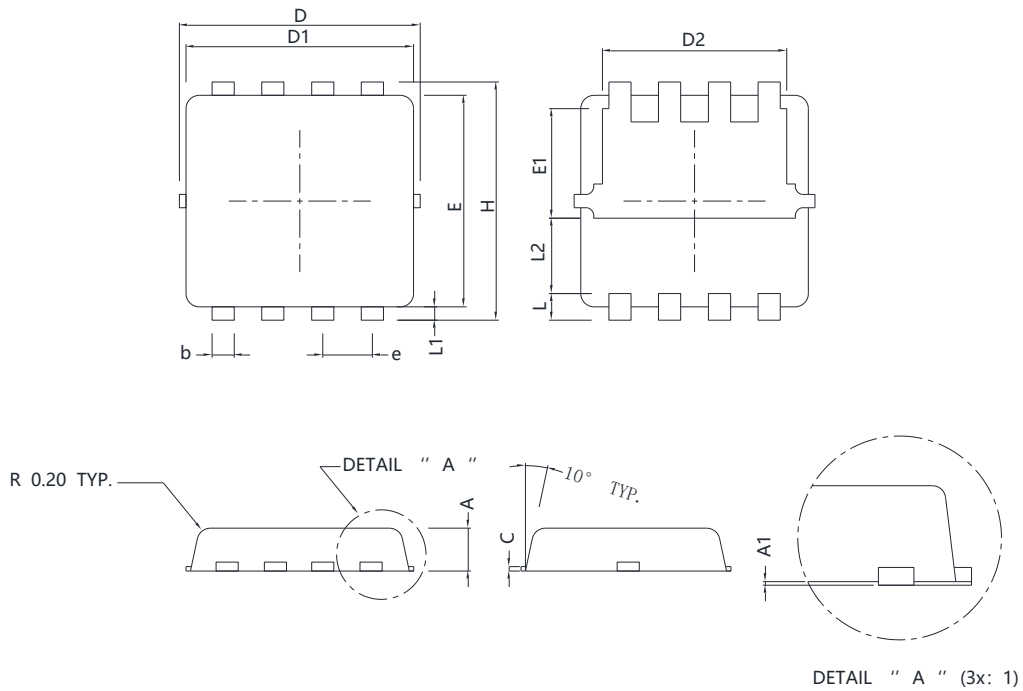

Figure 3. Unclamped inductive switching (UIS) test circuit & waveforms



Figure 4. Diode reverse recovery test circuit & waveforms

Package Information



Symbol	mm		
	Min	Nom	Max
A	0.70	0.80	0.90
A1	0.00	0.03	0.05
b2	0.24	0.30	0.35
c	0.10	0.15	0.2
D	3.25	3.32	3.40
D1	3.05	3.15	3.25
D2	2.40	2.50	2.60
E	3.00	3.10	3.20
E1	1.35	1.45	1.55
e	0.65 BSC		
H1	3.20	3.30	3.40
L	0.30	0.40	0.50
L1	0.10	0.15	0.20
L2	1.13 REF		

Version 1: PDFN3.3*3.3-K package outline dimension

Ordering Information

Package Type	Units/ Reel	Reels/ Inner Box	Units/ Inner Box	Inner Boxes/ Carton Box	Units/ Carton Box
PDFN3.3*3.3-K	5000	2	10000	6	60000

Product Information

Product	Package	Pb Free	RoHS	Halogen Free
SFS03R06NF	PDFN3.3*3.3	yes	yes	yes

Legal Disclaimer

The information given in this document shall in no event be regarded as a guarantee of conditions or characteristics. With respect to any examples or hints given herein, any typical values stated herein and/or any information regarding the application of the device, Oriental Semiconductor hereby disclaims any and all warranties and liabilities of any kind, including without limitation, warranties of non-infringement of intellectual property rights of any third party.

For further information on technology, delivery terms and conditions and prices, please contact the Oriental Semiconductor sales representatives (www.orientalsemi.com).

© Oriental Semiconductor Co.,Ltd. All Rights Reserved /